



Product Portfolio 2017



When it comes to heating water, it's a Redring thing

At Redring we've been successfully manufacturing hot water solutions for over 40 years. In fact, our comprehensive range of instantaneous and water storage heating products can trace its origins as far back as 1929.

Today, as part of the Glen Dimplex Group, our product portfolio is distinguished by its quality, convenience and affordability. We are proud to be driving forward standards of excellence to better meet the needs of installers and end users alike.



Why choose Redring?

We're working harder to make your life easier

At Redring we have always put our customers at the heart of everything we do. Our longstanding expertise in design and manufacturing is dedicated to developing outstanding showering and water heating products. We listen carefully to customer product expectations and strive to create the specific solutions they demand.

Showering

Our heritage has been built on creating showering experiences that combine quality with affordable design. And the confidence we have in our latest product range has allowed us to offer the extra reassurance of three-year warranties on two of our most recent models.

Water heating

We take pride in the convenience, efficiency and innovation of our comprehensive collection of instantaneous and stored water heating solutions and their capabilities to deliver hot water in a wide range of settings.

Meeting every need

Our continuing commitment to supporting every Redring customer together with our most recent product portfolio perfectly demonstrate how we're constantly working harder to make your life easier.

Contemporary design

At Redring we take pride in developing a range of great-looking products for everyday use.

Customer-inspired features

Each Redring product is designed to meet customer needs.

Rigorously tested

Every Redring product has been quality tested for reassurance and total peace of mind.

Redring heritage

We've been designing hot water solutions for more than 40 years.

Contents



Showers

Choosing your shower	10
Pure	12
Bright	14
Glow	16
Dash	18
Active & Active Plus	20
Expressions Revive	22
Expressions Revive Plus	24
Xpressions Premier	26
Slimline 650	28
Expressions 570	30
Expressions 520	32
Xpressions Eco-T	34
Selectronic Premier	36
Selectronic Premier Range	38
Accessory Kits	40



Water heating

ERP	46
Choosing your water heater	48

Instantaneous water heating solutions

Instant Electric Tap	52
Instant hand wash units	54
Powerstream & Powerstream Eco	56
Powerstream Ascari	58



Stored water heating solutions

MS Stored Water Heater	62
TS Stored Water Heaters	64
MW/EW Stored Water Heaters	66
WS Stored Water Heaters	68
CT Stored Water Heaters	70



Water boiling

Reditap	74
Sensaboil Beverage Boilers	76
SB Counter Top & Urn Boilers	78



Showers

Choosing your shower	10
Pure	12
Bright	14
Glow	16
Dash	18
Active & Active Plus	20
Expressions Revive	22
Expressions Revive Plus	24
Xpressions Premier	26
Slimline 650	28
Expressions 570	30
Expressions 520	32
Xpressions Eco-T	34
Selectronic Premier	36
Selectronic Premier Range	38
Accessory Kits	40

Choosing your shower

Once you've established your plumbing system, you can then decide on the type of electric shower you would like to install.

Electric showers

Suitable for all homes, connected directly to a cold mains water supply. Electric showers heat water on demand as it passes over a heating element for a hot shower at your desired temperature and flow.

Thermostatic electric showers

Suitable for all homes and connected directly to a cold mains water supply. Thermostatic showers are electric showers, with the added benefit of temperature control technology.

This maintains safe and constant water temperatures, even when water pressure changes, for example when a WC is flushed or washing machine used.

Pumped electric showers

Can be used in homes with low water pressure to give the benefit of an instantaneous shower without having a high mains water pressure.

Power showers

For low pressure systems only. Power showers use an integral pump to draw pre-heated hot and cold water from equal pressure stored supplies to deliver a balanced high volume shower.



Considerations

Look out for these key features when choosing your shower.

The higher the kW rating the more powerful the shower will be. An 8.5kW shower will provide up to 18% more flow than a 7.2kW, a 9.5kW 32% more and a 10.5kW up to 46% more.

However if you are opting for a different kW rated shower you must ensure that your wiring and fuse protection are compatible as follows:

- 7.2kW 30amps 6mm²
- 8.5kW 40amps 6-10mm²
- 9.5kW 45amps 10mm²
- 10.5 or 10.8kW 45amps 10-16mm²

Phased shutdown: Removes residual hot water, helping prevent the build-up of limescale and ensuring a safe starting temperature for the next user.

Energy efficiency ratings: Electric Showers feature the same energy labels as other domestic appliances. Buy with confidence and choose a model with the highest energy rating for optimum efficiency and minimum energy use.

Eco features: Reduce energy and water use. Unique features like timers that control shower durations and Eco Power functions that lower energy use to 65% can make a real difference.



Pure

Electric Shower

The all-new Pure shower from Redring combines attractive good looks with an even more attractive price point, making Pure the perfect choice for your cost-conscious homeowners who appreciate stylish design.

Key features

- 3 power settings
- Single mode shower head with rub clean nozzles
- Flexible accessory kit
- 600mm riser rail with brackets
- 1m anti-kink hose
- Plain shank for push-fit and compression cold water connection



Push button start/stop



Rub clean nozzles

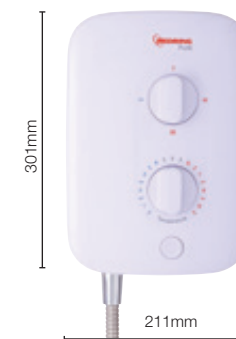

211mm



70mm

Catalogue Number	Model/Description	Energy Rating
53531301	RPS7 Pure 7.5kW	A
53531001	RPS8 Pure 8.5kW	A
53531101	RPS9 Pure 9.5kW	A
53531201	RPS10 Pure 10.5kW	A

Technical information

Performance: available in 7.5, 8.5, 9.5 and 10.5kW

Water: operating water pressure 1-10bar (15-150psi)

Entry points: 3 cable & 4 water (right hand side)

Approvals: BEAB & CE mark



2YR
WARRANTY

PUSH
BUTTON
START STOP

Bright

Electric Shower

At Redring we know installers' time is money. That's why our new Bright shower has been purposely designed to enable quick and easy installation, making it the ultimate replacement shower. Its 3 year warranty offers installers and homeowners that extra reassurance and is a demonstration of our confidence in this exciting new shower.

Key features

- SmartFit™ technology makes installation easy, thanks to multi-entry options
- 3 mode shower head with rub clean nozzles
- Left and right side entry
- Twin terminal block
- 600mm riser rail with brackets
- 1.25m anti-kink hose
- Plain shank for push-fit and compression cold water connection



Push button start/stop



3 mode shower head

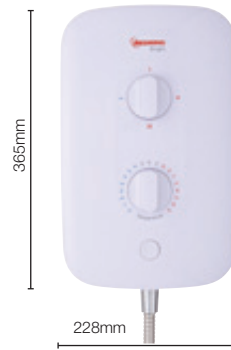

72mm

Catalogue Number	Model/Description	Energy Rating
53533301	RBS7 Bright 7.5kW	A
53533001	RBS8 Bright 8.5kW	A
53533101	RBS9 Bright 9.5kW	A
53533201	RBS10 Bright 10.5kW	A

Technical information

Performance: available in 7.5, 8.5, 9.5 and 10.5kW

Water: operating water pressure 1-10bar (15-150psi)

Entry points: 6 cable & 8 water

Approvals: BEAB & CE mark

NEW FOR
SUMMER 2017



SMARTFIT

3YR
WARRANTY

EASY
INSTALL

PUSH
BUTTON
START STOP

Glow

Electric Shower

The powerful combination of attractive design features, ease of installation and a reassuring 3 year warranty makes the new Glow shower an appealing package for both installers and homeowners. Featuring a 5 mode showerhead, chrome accents and a digital display, Glow also gives you the additional benefit of phased shutdown anti-scaling technology.

Key features

- SmartFit™ technology makes installation easy, thanks to multi-entry options
- Phased shutdown anti-scaling technology
- Digital temperature display
- 5 mode shower head with rub clean nozzles
- Left and right side entry
- Twin terminal block
- 600mm riser rail with brackets
- Chrome controls
- Plain shank for push-fit and compression cold water connection

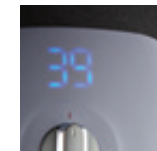

Large LED readout for clear visibility



5 mode shower head

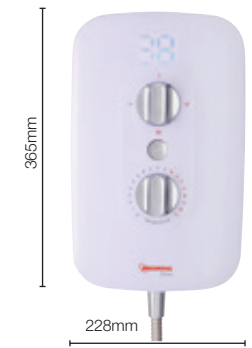

SMARTFIT

3YR
WARRANTY

EASY
INSTALL

PUSH
BUTTON
START STOP

Catalogue Number	Model/Description	Energy Rating
53535301	RGS7 Glow 7.5kW	A
53535001	RGS8 Glow 8.5kW	A
53535101	RGS9 Glow 9.5kW	A
53535201	RGS10 Glow 10.5kW	A

Technical information

Performance: available in 7.5, 8.5, 9.5 and 10.5kW

Water: operating water pressure 1-10bar (15-150psi)

Entry points: 6 cable & 8 water

Approvals: BEAB & CE mark

Dash

Electric Shower

Quick to fit, simple to use and easy to keep clean, the Dash electric shower offers exceptional value. Its compact and contemporary styling, reliable performance and A rating for energy efficiency make Dash a top quality choice.

Key features

- SmartFit™ technology makes installation easy, thanks to multi-entry options
- Choice of 8 water pipe entry points (compression and push fit) and 3 right hand side cable entry points
- Large, removable lower backplate improves working space
- Three power settings help control energy use and running costs
- Easy to use, with separate elevated dials for power select and flow control
- Supplied with accessory kit including hose, soap dish and easy clean showerhead with single spray mode



Smooth easy to clean fascia - no dirt traps



Multiple legacy wall fixings

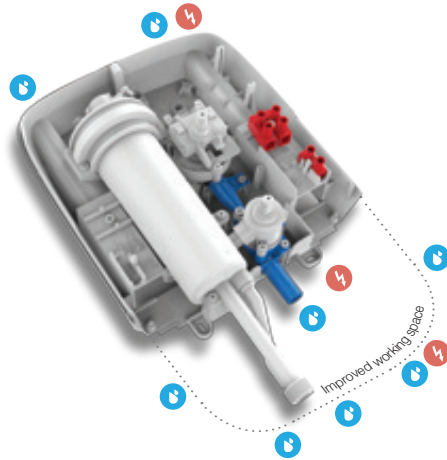

Catalogue Number	Model/Description	Energy Rating
53562801	RDS72 Dash 7.2kW	A
53562601	RDS85 Dash 8.5kW	A
53562401	RDS95 Dash 9.5kW	A

Technical information

Performance: available in 7.2, 8.5 and 9.5kW

Water: operating water pressure of 1-10bar (15-150psi), with 15mm plain shank push fit or standard compression fittings. Water pressure operated power switch

Entry points: 2 top, 2 bottom, 2 rear and 2 side options for water entry and right hand side top, bottom and rear options for cable entry

Approvals: BEAB & CE mark

SMARTFIT





Active Plus

Active and Active Plus

Electric Shower

Easy to install and simple to use, the affordable Active range is the ideal everyday electric shower. Offering great value for money and A rated for energy efficiency, the range also includes Active Plus models, with push button start/stop for even easier operation.

Key features

- Multiple fixing centres and removable corner sections allow for simple and speedy replacement of previous Redring Active showers
- Three power settings help control energy use and running costs
- Easy to use, with separate dials for flow control and 'set and forget' temperature control
- Active Plus models feature start/ stop push button and neon power and auto reset indicators
- Supplied with accessory kit including hose, soap dish and easy clean showerhead with single spray mode (Active) or three spray modes (Active Plus)

Catalogue Number	Model/Description	Energy Rating
53561001	A7 Active 7.2kW	A
53561201	A8 Active 8.5kW	A
53561601	AP7 Active Plus 7.2kW	A
53561801	AP8 Active Plus 8.5kW	A



Push button start/stop - Plus models

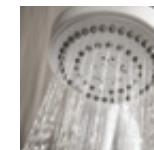

3 spray modes - Plus models

Technical information

Performance: available in 7.2 and 8.5kW

Water: operating water pressure of 1-10bar (15-150psi), with 15mm plain shank push fit or standard compression fittings. Electric solenoid operated power switch

Entry points: right hand top, bottom or rear for cable entry and right hand top, bottom rear or side for water entry

Approvals: BEAB & CE mark



Active

Expressions Revive

Electric Shower

Best in its class, the superior Expressions Revive offers unrivalled flexibility and ease of installation, while its sleek, slim profile and contemporary chrome accessories blend beautifully with modern bathrooms.

Key features

- SmartFit™ connectivity makes installation easy, thanks to multi-entry options
- Choice of 8 water pipe entry points (compression and push fit), 6 cable entry points and left or right hand electrical dual terminal block connections
- Large, removable lower backplate improves working space
- Multiple legacy wall fixings for easy replacement of existing showers
- Special push fit to compression adaptor included as standard for universal installation
- Full chrome accessory FlexiFit™ kit included, complete with riser rail, hose and showerhead with six spray modes
- Easy to use, with start/stop push button and separate elevated dials for temperature and flow control
- Power on neon indication



DIY filter removal for cleaning



Special push fit to compression adaptor



FlexiFit™ adjustable rail bracket

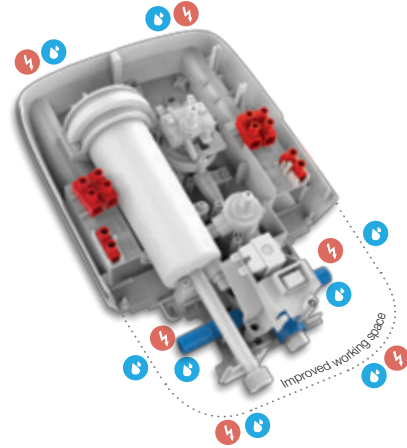

Catalogue Number	Model/Description	Energy Rating
53563002	X7R Expressions Revive 7.2kW	A
53563202	X8R Expressions Revive 8.5kW	A
53563402	X9R Expressions Revive 9.5kW	A

Technical information

Performance: available in 7.2, 8.5 and 9.5kW

Water: operating water pressure 1-10bar (15-150psi), with 15mm plain shank for push fit or standard 1/2" BSP compression fittings

Entry points: 2 top, 2 bottom, 2 rear and 2 side options for compression and push fit pipe connections and 2 top, 2 bottom and 2 rear options for cable entry

Approvals: BEAB & CE mark



SMARTFIT

2YR
WARRANTY

6 MODE
SHOWER
HEAD

IPX4
RATED





SMARTFIT

2YR
WARRANTY

6 MODE
SHOWER
HEAD

IPX4
RATED

Expressions Revive Plus

Electric Shower

Along with all the great features of the Expressions Revive, the Plus model adds Phased Shutdown technology. Plus unrivalled flexibility and ease of installation, while its sleek, slim profile and contemporary chrome accessories blend beautifully with modern bathrooms.

Key features

- SmartFit™ connectivity makes installation easy, thanks to multi-entry options
- Choice of 8 water pipe entry points (compression and push fit), 6 cable entry points and left or right hand electrical connections
- Large, removable lower backplate improves working space
- Multiple legacy wall fixings for easy replacement of existing showers
- Special push fit to compression adaptor included as standard for universal installation
- Full chrome accessory FlexiFit™ kit included, complete with riser rail, hose and showerhead with six spray modes
- Easy to use, with start/stop push button and separate elevated dials for temperature and flow control
- Phased shutdown anti-scaling for longer element life

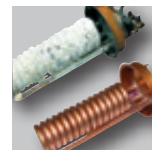

Phased shutdown = anti-scale



DIY filter removal for cleaning



FlexiFit™ adjustable rail bracket

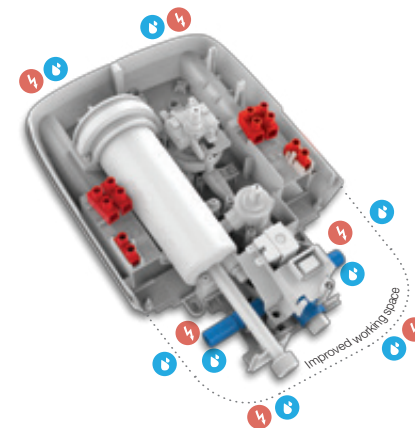

Catalogue Number	Model/Description	Energy Rating
53565002	XP7R Expressions Revive Plus 7.2kW	A
53565202	XP8R Expressions Revive Plus 8.5kW	A
53565402	XP9R Expressions Revive Plus 9.5kW	A

Technical information

Performance: available in 7.2, 8.5 and 9.5kW

Water: operating water pressure 1-10bar (15-150psi), with 15mm plain shank push fit or standard 1/2" BSP compression fittings

Entry points: 2 top, 2 bottom, 2 rear and 2 side options for compression and push fit pipe connections and 2 top, 2 bottom and 2 rear options for cable entry

Approvals: BEAB & CE mark

Xpressions Premier

Electric Shower

Combining installation flexibility with an array of advanced features, the Xpressions Premier makes a statement. Push button controls mean ultimate convenience and the timer function gives users control over shower duration, saving water and energy.

Key features

- SmartFit™ technology makes installation easy, with 8 water entry points, 6 cable entry points and twin terminal blocks for left or right hand electrical connections
- Advanced Scale Flush feature removes hot water to prevent limescale build-up
- Phased shutdown means shower is safe and cooler for next user
- Removable easy clean inlet filter
- FlexiKit™ accessory pack includes sliding bracket fixing, hose, soap dish and easy clean showerhead with six spray modes
- Easy to use, with start/stop push button, LED power indicators and separate elevated dials for 'set and forget' temperature and flow control

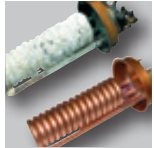

Phased shutdown = anti-scale



Power selection



FlexiKit™ adjustable rail bracket

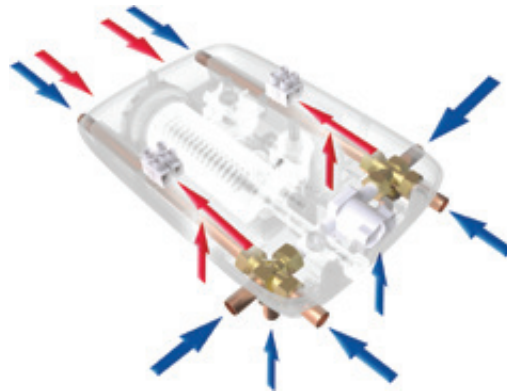

SMARTFIT



Catalogue Number	Model/Description	Energy Rating
53564001	XPR8 Xpressions Premier 8.5kW	A
53564201	XPR9 Xpressions Premier 9.5kW	A

Technical information

Performance: available in 8.5 and 9.5kW

Water: operating water pressure of 1-10bar (15-150psi), with 15mm plain shank push fit or standard compression fittings

Entry points: 2 top, 2 bottom, 2 rear and 2 side options for water entry and 2 top, 2 bottom and 2 rear options for cable entry

Approvals: BEAB & CE mark



2YR
WARRANTY

6 MODE
SHOWER
HEAD

IPX4
RATED

Slimline 650

Electric Shower

Super slim, with striking aesthetics and easy push-button control, the Slimline 650 electric shower is perfect for contemporary bathrooms, where style and space are key. A rated for energy efficiency, this is a clever, compact and convenient shower.

Key features

- Ultra slim 70mm profile for contemporary, space-saving style
- Removable side section and multiservice points for easy installation
- Advanced Scale Flush feature removes hot water to prevent limescale build-up
- Phased shutdown means shower is safe and cooler for next user
- Available in white or chrome
- Supplied with accessory kit including hose, soap dish and easy clean showerhead with six spray modes
- Chrome models feature a handy FlexiKit™ sliding fixing brackets make replacement installations easy
- Easy to use, with start/stop push button, 3 power control push buttons and dial for 'set and forget' temperature control

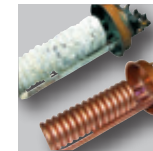

Phased shutdown = anti-scale



Start/stop and power selection



FlexiKit™ adjustable rail bracket (chrome model)



Ultra slim 70mm profile



Chrome

Catalogue Number	Model/Description	Energy Rating
53557201	R6508 Slimline 650 8.5kW White	A
53558201	R6509 Slimline 650 9.5kW White	A
53559201	R65010 Slimline 650 10.5kW White	A
53557202	R6508C Slimline 650 8.5kW Chrome	A
53558202	R6509C Slimline 650 9.5kW Chrome	A

Technical information

Performance: available in 8.5, 9.5 and 10.5kW

Water: operating water pressure 1-10bar (15-150psi) with 15mm plain shank push fit or standard compression fittings

Entry points: right hand top, bottom and rear for water and cable entry

Approvals: BEAB & CE mark

Expressions 570

Pump Assisted Instant Electric Shower

For homes with low mains water pressure, the Expressions 570 pumped electric shower is ideal. A rated for energy efficiency, its built-in booster pump delivers all the convenience and efficiency of electric showering, regardless of water pressure.

Key features

- Integrated booster pump provides constant water supply from a cold water header tank
- Choice of high or low power modes to manage flow and energy use
- Accessory kit includes hose, soap dish and easy clean showerhead with six spray modes
- Easy to use, with separate elevated dials for 'set and forget' temperature and flow control
- Neon power and overheat indicators



Depth 113mm

Catalogue Number	Model/Description	Energy Rating
24555515	EXP5708 Expressions 570 8.5kW	A
24556015	EXP5709 Expressions 570 9.5kW	A

Technical information

Performance: available in 8.5 and 9.5kW (maximum flow rate 7.0 litres/min)

Water: cold water cistern fed, with operating water pressure 3" minimum head to 33" maximum head (0.08m to 10m). 15mm push fit connection

Power: the unit incorporates a 240V 140W AC motor to boost flow

Entry points: right hand top, bottom and rear for water and cable entry

Approvals: BEAB & CE mark



2YR
WARRANTY

6 MODE
SHOWER
HEAD

IPX4
RATED

Expressions 520

Power Shower

Luxurious and powerful, the premium Expressions 520 power shower mixes and delivers up to 14 litres of water per minute from stored hot and cold water supplies for an invigorating showering experience.

Key features

- Ideal for gravity fed systems and available as manual or thermostatic power shower
- Mixer valve blends stored hot and cold water to provide the ideal showering temperature
- Integrated booster pump guarantees powerful spray, where low water pressure can prevent high volumes of water
- Thermostatic option maintains constant, comfortable and safe water temperatures, even when incoming water pressures and temperatures change
- Easy and simple to install, taking water from the cylinder and header tanks
- Adjustable temperature limiter with override feature allows maximum water temperatures to be set
- Easy to use, with separate elevated dials for start/stop and flow control, and 'set and forget' temperature control
- Supplied with accessory kit including hose, soap dish and easy clean showerhead with multiple spray modes



2YR
WARRANTY

6 MODE
SHOWER
HEAD

IPX4
RATED

Catalogue Number	Model/Description
46598415	EXM520WC Expressions 520M Manual Mixer
46599415	EXTS520WC Expressions 520TS Thermostatic Mixer



Technical information

Performance: maximum flow 14 litres/min manual - 12 litres/min thermostatic

Power: motor 140W at 240V

Water: gravity fed, with operating water pressure 3" minimum head to 33' maximum head (0.08m to 10m). Push fit connections

Entry points: right hand top, bottom and rear for water and cable entry

Approvals: BEAB & CE mark

Xpressions Eco-T

Thermostatic Electric Shower

Safe, intelligent and A rated for energy efficiency, the Xpressions Eco-T electric thermostatic shower is ideal for busy family bathrooms. Guaranteed water temperatures provide peace of mind, while unique timer and Eco features save valuable time, water and energy.

Key features

- Thermostatic technology maintains safe water temperatures within +/-1.5°C, even when water pressures change
- Energy saving Eco Power button adjusts flow rates to reduce energy use by 65%
- Unique timer function controls shower durations for energy and time efficient showering
- Removable side section for ease of installation
- Advanced Scale Flush feature removes hot water to prevent limescale build-up
- Supplied with accessory kit including hose, soap dish and easy clean showerhead with six spray modes
- Easy to use, with start/stop push button, LED indicator and separate elevated dial for 'set and forget' temperature control



Catalogue Number	Model/Description	Energy Rating
53677701	EXT7 Xpressions Eco-T 7.2kW	A
53678701	EXT8 Xpressions Eco-T 8.5kW	A
53679701	EXT9 Xpressions Eco-T 9.5kW	A

Technical information

Performance: available in 7.2, 8.5 and 9.5kW

Water: operating water pressure of 0.7-10bar (10-145psi), with water flow operated power switch and 15mm standard compression fittings (Note – this shower will not operate below 0.7bar)

Entry points: right hand side top, bottom or rear for cable and water entry

Approvals: BEAB & CE mark



2YR
WARRANTY

6 MODE
SHOWER
HEAD

IPX4
RATED



Standard model accessories



Selectronic Premier

Thermostatic Electric Shower

Trusted by care professionals, Selectronic Premier is one of the safest, most caring and intelligent thermostatic showers. Offering unparalleled peace of mind and an A rating for energy efficiency, Selectronic Premier provides a comfortable and intuitive showering experience for everyone.

Key features

- Accurate thermostatic technology maintains safe water temperatures within +/-0.5°C
- Maximum temperature lock setting can be set at installation to prevent any accidental temperature increases
- One touch start/stop and temperature control buttons, plus large LED display and audio feedback for clear operation and setting adjustment
- Eco Power function, when set at installation, will automatically adjust flow rates to reduce energy use
- Smart data logging technology records usage data to assist service engineers
- One button commissioning for simple and speedy installation
- Supplied with accessory kit including hose, soap dish and easy clean showerhead with six spray modes
- Longer 1m riser rail and 2m hose allows users to comfortably operate the shower whilst seated (Plus and Remote models)
- Remote control option allows shower to be operated by carers from outside the enclosure or screen (Remote models only)

Catalogue Number	Model/Description	Energy Rating
53677501	SELP85S Selectronic Premier STD 8.5kW	A
53678501	SELP95S Selectronic Premier STD 9.5kW	A
53679501	SELP108S Selectronic Premier STD 10.8kW	A

Technical information

Performance: available in 8.5, 9.5 and 10.8kW

Water: operating water pressure 0.7-10bar (10-145psi), with 15mm inlet connection

Entry points: right hand side, top, bottom and rear for both water and cable (up to 16mm²)

Approvals: BEAB, BEAB care, RNIB, WRAS & CE



Simple and easy tactile button operation



Accurate Temperature control with Templock setting options



Large LED readout for clear visibility

* 3 year warranty can be extended to 5 year by returning your completed registration form within 30 days of purchase.

Selectronic Premier

Thermostatic Electric Shower



Premier models are supplied with a soap dish, hose retainer, 6 mode shower head, **456mm riser rail and a 1.25 metre flexible shower hose.**

Catalogue Number	Model/Description
53677501	SELP85S Selectronic Premier STD 8.5kW
53678501	SELP95S Selectronic Premier STD 9.5kW
53679501	SELP108S Selectronic Premier STD 10.8kW



Premier Plus models are supplied with a soap dish, hose retainer, 6 mode shower head, **1 metre riser rail and a 2 metre flexible shower hose.**

Catalogue Number	Model/Description
53677505	SELP85P Selectronic Premier PLUS 8.5kW
53678505	SELP95P Selectronic Premier PLUS 9.5kW
53679505	SELP108P Selectronic Premier PLUS 10.8kW



Premier Remote models are supplied with a soap dish, hose retainer, 6 mode shower head, 1 metre riser rail, 2 metre flexible shower hose **and a start/stop remote control.**

Catalogue Number	Model/Description
53677510	SELP85PR Selectronic Premier REMOTE 8.5kW
53678510	SELP95PR Selectronic Premier REMOTE 9.5kW
53679510	SELP108PR Selectronic Premier REMOTE 10.8kW

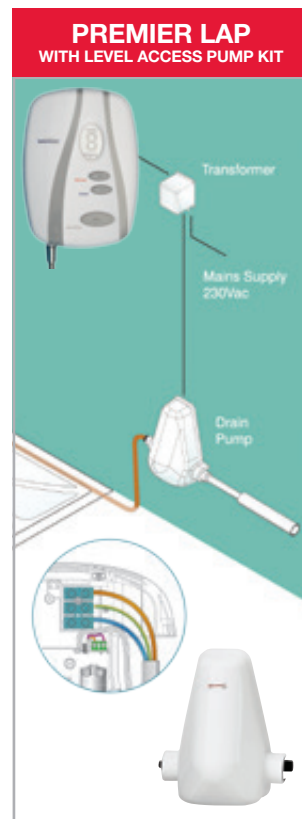

Premier LAP models are supplied with a soap dish, hose retainer, 6 mode shower head, 1 metre riser rail, 2 metre flexible shower hose, Start/ stop remote control **and a full level access pump kit.**

Catalogue Number	Model/Description
53677590	SELP85LAP Selectronic Premier PLUS 8.5kW
53678590	SELP95LAP Selectronic Premier PLUS 9.5kW

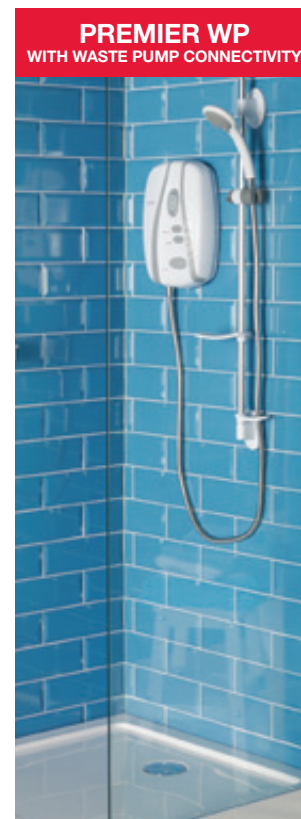

Premier WP models are supplied with a 6 mode shower head, 1 metre riser rail, and a 2 metre flexible shower hose. **The shower has connection terminals for 2 and 3 wire linking to popular waste pumps.**

Catalogue Number	Model/Description
53677515	SELP85WP Selectronic Direct Pump Link 8.5kW
53678515	SELP95WP Selectronic Direct Pump Link 9.5kW

Selectronic
Trusted • Caring • Intelligent

5YR*
WARRANTY

6 MODE
SHOWER
HEAD

IPX5
RATED

* 3 year warranty can be extended to 5 year by returning your completed registration form within 30 days of purchase.



Accessory Kits

The Redring range of accessories adds a stylish finishing touch to electric shower installations. Choose from showerhead kits in a range of styles, all guaranteed to enhance the showering experience.



Model: STDKITW
Cat No: 83595340

Standard white and chrome kit with a single spray mode showerhead



Model: PREMKIT3W
Cat No: 83595341

Premium white and chrome kit with three spray mode showerhead



Model: PREMKIT6W
Cat No: 83595342

Premium white and chrome kit with six spray mode showerhead



Model: FLEKIT3W
Cat No: 83595343

FlexiKit™ white and chrome kit with a three spray mode showerhead and adjustable top bracket



Model: FLEKIT6W
Cat No: 83595344

FlexiKit™ white and chrome kit with six spray mode showerhead and adjustable top bracket

Accessory Kits



Model: SAK1W
Cat No: 83595402

Standard white and chrome kit with a single spray mode showerhead



Model: SAK3W
Cat No: 83595403

Premium white and chrome kit with three spray mode showerhead



Model: SAK5W
Cat No: 83595404

Premium white and chrome kit with five spray mode showerhead



Model: FLEXKIT6C
Cat No: 83595345

FlexiKit™ all chrome kit with six spray mode showerhead and adjustable top bracket



Model: CCP2
Cat No: 83595329

Care pack white FlexiKit™ with 2mtr hose and 1mtr riser rail to assist seated shower users



Model: CCP3
Cat No: 83595335

Care pack white and chrome FlexiKit™ with 2mtr hose and 1mtr riser rail to assist seated shower users

Water heating



ERP 46

Choosing your water heater 48

Instantaneous water heating 50

Stored water heating solutions 60

Water boiling 72



ERP Legislation

All applicable Redring water heating products have published ERP ratings, available on our website and in literature with labelling included in the product packaging.

- All Redring instantaneous water heaters are A rated.
- Redring stored water heaters are B, C or E rated.
- Boiling water products are exempt from compliance.

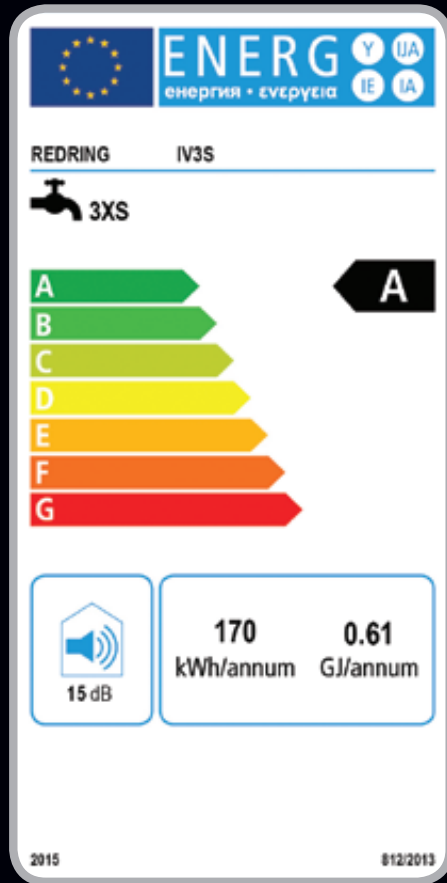

We're here to help

At Redring, we're committed to providing you with high quality service every step of the way. Whether you need advice about products or you require information, our dedicated technical support team is on hand to help with your enquiry.

TECHNICAL SUPPORT
0844 372 7766*

Monday to Friday 8.30 - 17.00
technical.services@redringxpelair.com





*Calls cost 7p per minute plus your telephone company's network access charge.





Choosing your water heater

Redring water heaters offer a range of technologies and features - use the table below to help decide which would best suit your application.

	Instantaneous Water Heating			
				
	TAP1 Instant Hot Water Tap	I3VS & AV3S Instant Hand Wash Units	RP Inline Instantaneous Water Heaters	PSA Electric Heating Flow Boiler
Hand Washing	●	●	●	*
Dish Washing				*
Showering			●	*
Space Heating				●
Beverage Making				
Food Preparation				
Single Outlet	●	●	●	
Multi-outlet			●	

	Stored Water Heating				
					
	MS Mini 6L Stored Water Heater	TS 10 & 15L Stored Water Heaters	MW & EW 10 & 15L Stored Water Heaters	WS 7L Stored Water Heaters	CT 25 & 50L Stored Water Heaters
Hand Washing	●	●	●		●
Dish Washing	●	●	●	●	●
Showering					
Space Heating					
Beverage Making					
Food Preparation					
Single Outlet	●	●	●	●	●
Multi-outlet		●	●		●

	Water Boiling		
			
	REDITAP Boiling Water Taps	SB Beverage Water Boilers	SB Counter Top & Water Boiling Urn
Hand Washing			
Dish Washing	●		
Showering			
Space Heating			
Beverage Making	●	●	●
Food Preparation	●	●	●
Single Outlet	●	●	●
Multi-outlet			

* When used in conjunction with an indirect stored water cylinder.

Instantaneous water heating solutions

Instant Electric Tap	52
Instant hand wash units	54
Powerstream & Powerstream Eco	56
Powerstream Ascari	58



Instant Electric Tap

Instantaneous Electric Hot Water Tap

A simple yet highly effective way of providing instant hot water, the tap efficiently delivers both heated and cold water for washing your hands in utility rooms, workshops, garages and other locations with no alternative hot water supply.

Key features

- Simply plugs into a standard domestic UK socket or can be wired into a fused spur outlet, and requires only a cold water supply
- Heats only the water required at the point of use to save energy and reduce running costs
- Compact design with directional swivel spout which is easily removable for cleaning
- Simple solution for hand wash basin mixer tap
- Water saving flow limiter and thermal safety cut-out protection



Catalogue Number	Model/Description	Energy Rating
43679001	TAP1 Instant Hot Water Tap	A

Technical information

Heating: 2.5kW@240V metal sheathed heating element with thermal protection

Cable connection: Supplied fitted with 1 metre cable with UK plug

Operating pressure: 0.35 - 6bar

Water connection: 3/4" x 15mm tap connector

Dimensions: 140mm (w) x 185mm (h) x 185mm (d), Pillar 54mm dia

Approvals: CE mark

Ingress Protection: IPX4



1YR
WARRANTY

EASY
INSTALL



Instant Hand Wash Units

Instantaneous Hand Washing Water Heaters

Wherever customers or colleagues need convenient hot water for hand washing on demand, Redring instant hand washing units are ideal. A rated for energy efficiency, they're easy to fit and use with touch-free models for hygiene-sensitive environments.

Key features

- Easy replacement for all previous Redring I3V units
- 3kW element for rapid heating, with safety overheat protection for peace of mind
- Manual I3VS features a single temperature/flow control for ease of operation
- Auto AV3S offers infrared touch free operation, ideal for high care applications and hygiene sensitive areas
- Compact and robust, with a 200mm swivel arm and anti-vandal spray head for easy water dispensing
- Unique Vortex technology improves flow and prevents limescale build-up
- Auto AV3S has simple installer commissioning to ensure optimum performance and features a 40 second timed shut off to save water and energy
- Neon light indicates unit in use



Catalogue Number	Model/Description	Energy Rating
43678901	I3VS Manual Hand Wash	A
43679901	AV3S Autosensor Hand Wash	A

Technical information

Heating: 3kW@240V metal sheathed heating element with thermal protection

Cable connection: Top, bottom or rear 13amps (1.5mm² minimum)

Operating pressure: 0.7 - 7bar

Water connection: Cold water mains 1/2" BSP (15mm) bottom entry

Dimensions: I3VS 140mm (w) x 228.5mm (h) x 99mm (d)

AV3S 140mm (w) x 228.5mm (h) x 83.5mm (d)

Approvals: BEAB & CE mark

Ingress Protection: IPX4

1YR
WARRANTY

EASY
INSTALL

Powerstream & Powerstream Eco

Unvented Inline Instantaneous Water Heaters

With no need for storage cylinders, the Powerstream range of unvented instantaneous water heaters provides you with a fast, convenient and space-saving source of hot water on demand for use in ensuite shower rooms, small washrooms, cloakrooms and utility rooms.

Key features

- Small and compact design eliminates the need for long inefficient pipe runs to a centrally located cylinder, saving space and energy
- Ideal for hand basin supply in commercial and residential properties with restricted access to stored hot water
- Suitable with two hand basins or a manual mixer shower and hand basin
- Eco models feature user power selection (High, Eco, Low and Cold)



Powerstream



Powerstream Eco



Pair of LT1 Powerstream 1/4 turn lever spray taps Cat No: 85793616



RM1 manual mixer shower accessory for use with a shower and a hand basin Cat No: 85793620

Catalogue Number	Model/Description	Energy Rating
45793201	RP1 Powerstream 9.5	A
45793204	RP10.8 Powerstream 10.8	A
45793202	RP12 Powerstream 12	A
45673201	RP1E Powerstream Eco 9.5	A
45673202	RP10.8E Powerstream Eco 10.8	A

Technical information

Heating: 9.5, 10.8 & 12kW@240V heating elements with thermal protection

Cable connection: Bottom or rear 6-10mm² (9.5)
10-16mm² (10.8) 16mm² (12)

Operating pressure: 1 - 10bar

Materials: Corrosion resistant steel backplate with thermoplastic cover

Water connection: Cold water mains 15mm plain shank bottom entry

Dimensions: **Powerstream** 307mm (w) x 160mm (h) x 72mm (d)
Powerstream Eco 307mm (w) x 160mm (h) x 84mm (d)

Approvals: BEAB & CE mark

Ingress Protection: IPX4



2YR
WARRANTY

EASY
INSTALL



EASY
INSTALL

COMPACT
DESIGN

LOW
NOISE

Powerstream Ascari

Central Heating Electric Flow Boiler

The Ascari gives landlords and homeowners alike a fast, effective and safe way to heat water for wet radiator or underfloor heating in studio apartments, loft conversions or extensions as an alternative to gas, oil, propane, solid fuel or electric storage heating.

Key features

- Ideal for well insulated properties of up to 80m²
- Suitable for use with sealed, open vented and unvented wet central heating and hot water systems, with no need for flues or fuel tanks
- Integral 3 speed circulation pump, 8 litre expansion vessel, and 3bar pressure relief valve for ease of installation
- 5 litre hot water storage
- Will heat domestic hot water when used in conjunction with an indirect stored water cylinder
- Stainless steel elements and frost protection provide durability
- Low maintenance, with no requirement for an annual service (5 year safety check only)
- Ability to set water temperature between 21°C and 80°C helps control energy use
- Easy to use 7 segment control panel with digital temperature and pressure displays
- 3 year UK manufacturers warranty on tank and 2 year on other components



Catalogue Number	Model/Description	Energy Rating
45551860	PSA12 Powerstream Ascari	D

Technical information

Performance: Maximum 12kW@240V (convertible to 10, 8, 6 or 4kW at installation)

Water: Operating water pressure of 0.5 - 3bar

Entry points: Top and bottom for cable entry

Dimensions: 405mm (w) x 620mm (h) x 280mm (d)

Ingress Protection: IPX4



Stored water heating solutions

MS Stored Water Heater 62

TS Stored Water Heaters 64

MW/EW Stored Water Heaters 66

WS Stored Water Heaters 68

CT Stored Water Heaters 70



MS6 Mini Stored Water Heater

Compact 6 litre unvented Stored Water Heater

Fitting neatly inside a kitchen cupboard, the MS6 is the ideal single outlet installation for rapid water heating in kitchens, bathrooms, outbuildings and extensions where access to a centrally located hot water system is not possible.

Key features

- 1.5kW heating element for rapid heat up and recovery
- Thermostatic control up to 70°C with thermal cut-out safety protection
- Heating element 'ON' neon indicator
- Rustproof, erosion free glass lined tank for long life and higher energy efficiency
- Glass ceramic water tank with magnesium sacrificial anode protection
- High density thermal CFC-free polyurethane insulation to minimise heat loss
- Supplied with accompanying pressure relief valve, dielectric connectors and wall mounting bracket



Catalogue Number	Model/Description	Energy Rating
47789701	MS6 6Ltr Stored Water Heater	C

In small unvented water heaters the hot water expansion can often be accommodated back into the cold water mains supply, as indicated in the Water Regulations. Where this is not possible the installer will need to fit a set of cold water controls (See images on page 25).

Technical information

Capacity: 6Litres

Cable connection: Supplied with fitted 1m cable and UK plug

Power: 1.5kW@240V (6.5Amp)

Water: Maximum operating pressure 8bar - 1/2" BSP male connections

Product weight (empty): 4.7kg

Dimensions: 270mm (w) x 270mm (h) x 255mm (d)

Approvals: CE mark

Ingress Protection: IPX4



TS Stored Water Heaters

Small Capacity Unvented Stored Water Heaters

The TS range quickly and effectively provides hot water on demand for up to four outlets simultaneously from a mains pressurised water supply. With a compact shape for under sink mounting, both units work equally well as a single kitchen sink installation.

Key features

- Adjustable rotary thermostat with 'heating' LED indicator
- Maximum temperature 70°C with 60°C Eco setting and frost protection
- Glass ceramic water tank with magnesium sacrificial anode protection
- Supplied with accompanying pressure relief valve, dielectric connectors and wall mounting hooks
- Thermal Insulation 20mm ±4mm and stainless steel water outlet
- Removable flange for easy access to magnesium anode and heating element



Catalogue Number	Model/Description	Energy Rating
47789501	TS10 10Ltr Stored Water Heater 2kW	C
47789601	TS15 15Ltr Stored Water Heater 2kW	C

Accessories

87783101	CWP Cold Water Control Pack
87783103	TBV Thermostatic Blending Valve
97783236	TUN Tundish 1/2" male 3/4" female

In small unvented water heaters the hot water expansion can often be accommodated back into the cold water mains supply, as indicated in the Water Regulations. Where this is not possible the installer will need to fit a set of cold water controls.

Technical information

Capacity: 10Litres & 15Litres

Cable connection: Supplied with fitted 1.5m cable and UK plug

Power: 2kW@240V

Water: Maximum operating pressure 6bar - 1/2" BSP connections

Dimensions: 10L 370mm (w) x 410mm (h) x 250mm (d)

15L 370mm (w) x 410mm (h) x 310mm (d)

Approvals: CE mark

Ingress Protection: IPX4



Cold water control pack



Tundish



Thermostatic Blending Valve



1 YR
WARRANTY

EASY
INSTALL

MW/EW Stored Water Heaters

Small Capacity Unvented Stored Water Heaters

Designed for wall or floor mounting with superior insulation to minimise heat loss and save energy, the MW/EW range offers hot water on demand from a single kitchen sink right up to four hand basin outlets simultaneously from a mains pressurised water supply.

Key features

- Superior insulation combined with short pipe runs minimises heat loss, saving energy
- Provides a balanced hot and cold water supply, via existing taps or mixers for convenience
- Adjustable thermostat up to 70°C, with safety cut-out protection
- Fitted magnesium sacrificial anode for tank protection
- Supplied with dielectric connectors, wall bracket and fixings

Catalogue Number	Model/Description	Energy Rating
47789101	MW10 10Ltr 3kW water heater	B
47789201	MW15 15Ltr 3kW water heater	B
47789301	EW10 10Ltr 3kW water heater	B
47789401	EW15 15Ltr 3kW water heater	B

Accessories

87783101	CWP Cold Water Control Pack
87783103	TBV Thermostatic Blending Valve
97783236	TUN Tundish 1/2" male 3/4" female

In small unvented water heaters the hot water expansion can often be accommodated back into the cold water mains supply, as indicated in the Water Regulations. Where this is not possible the installer will need to fit a set of cold water controls (See images on page 25).

Technical information

Capacity: 10Litres & 15Litres

Cable connection: Rear bottom right entry

Power: 3kW@240V

Water: Operating water pressure 1 - 12bar (above 6bar a cold water pack is required) Inlet/outlet connections 15mm (1/2" BSP)

Dimensions: 10L 360mm (w) x 410mm (h) x 254mm (d)
15L 360mm (w) x 410mm (h) x 300mm (d)

Approvals: BEAB & CE mark

Ingress Protection: IPX4



MW - factory fitted temperature and pressure relief device



EW - accompanying 6bar expansion relief valve

1YR
WARRANTY

EASY
INSTALL

WS Stored Water Heaters

Direct Dispense Stored Water Heaters

For readily available stored hot water at point of use, WS vented stored water heaters come complete with a swivel spout for over sink mounting and are an ideal solution for intermittent dishwashing and similar applications in a small cafe or office kitchen.

Key features

- Adjustable thermostat with 15-75°C temperature range with frost protection setting
- Over temperature safety fuse protection for peace of mind
- 300mm swivel spout, perfect for dishwashing
- Optional 450mm and 600mm spouts also available
- Monoblock chrome vented mixer tap accessory for undersink mounting option



Catalogue Number	Model/Description	Energy Rating
44780001	WS73 Storage Water Heater 3kW	B

Accessories

84780408	MCM monoblock chrome vented mixer tap
84780404	S1 450mm extended swivel spout
84780405	S2 600mm extended swivel spout



Monoblock chrome vented mixer tap accessory for undersink mounting option

Technical information

Capacity: 7Litres

Cable connection: Bottom entry

Power: 3kW@240V

Water: Operating pressure 0.7 - 10bar, 15mm cold water compression

Dimensions: 278mm (w) x 400mm (h) x 232mm (d)

Approvals: BEAB & CE mark

Ingress Protection: IPX4



2YR
WARRANTY

EASY
INSTALL

CT Stored Water Heaters

Flatback Cistern Type Water Heaters

Designed for wall mounting above the sink or basin, these compact water heating solutions are ideal for the delivery of large volumes of stored hot water to multiple outlets in small commercial kitchens and canteens, industrial bathrooms and cloakrooms.

Key features

- Cold water cistern tank incorporated cistern ball valve assembly and drain connection
- Both left and right side overflow and cold feed connection options for ease of installation
- Dual adjustable thermostats, factory set 50°C for temperature control and 70°C high limit for overheat protection
- 3kW long life Incoloy sheathed heating elements and high density foam insulation to reduce heat loss
- Copper water vessel with corrosion proofed enamel finished steel case
- Mounted 1 metre above draw off point to ensure good flow rate



Catalogue Number	Model/Description	Energy Rating
26786401	CT25 Flatback Water Heater 25L	E
26786801	CT50 Flatback Water Heater 50L	E

Technical information

Capacity: 25Litres & 50Litres

Cable connection: Bottom entry

Power: 3kW

Water: Operating pressure 0.7 - 10bar, with 1/2" BSP cold water and 22mm compression fitting hot water connections

Dimensions: 25 litre 470mm (w) x 705mm (h) x 210mm (d)
50 litre 600mm (w) x 750mm (h) x 320mm (d)

Approvals: CE mark

Ingress Protection: IPX4



2YR
WARRANTY

EASY
INSTALL

Water boiling



Reditap	74
Sensaboil Beverage Boilers	76
SB Counter Top & Urn Boilers	78



2YR
WARRANTY

£
AFFORDABLE
PRICE

PIPING
HOT

Reditap Boiling Taps

3 in 1 Boiling Water Kitchen Mixer Tap

An attractive and affordable boiling water kitchen mixer tap dispensing boiling water for making hot drinks and preparing food as well as mixing hot and cold water from an existing supply for washing up, cleaning and other household activities.

Key features

- Available in high quality bright chrome or brushed nickel tap finishes to suit sink material and décor
- Compact 2 litre boiling tank offering a greater capacity than domestic kettles, but with minimal loss of cupboard space
- Simple, speedy connection - drain valve assembly and all hose fittings supplied
- Easy tank access for inspection and descaling where required
- Boiling calibration control with thermal overheat protection
- Heating element 'ON' indication
- High density CFC free polystyrene insulation to minimise heat loss
- Fitted with cable and UK plug



Catalogue Number	Model/Description
22566802	RTTC REDITAP 3 in 1 boiling tap (Chrome)
22566803	RTTB REDITAP 3 in 1 boiling tap (Brushed Nickel)

Technical information

Capacity: 2 Litres
Power: 1kW@230V
Inlet/outlet connections: 1/2" BSP male
Tank Inlet connection: 1/4" push fit
Tank outlet: 8mm plain shank
Drain Valve: 3/8" BSPP thread
Flow rate: 1.8 litres/minute
Tank Dimensions: 217mm (w) x 236mm (h) x 176mm (d)

Time to heat up from cold: 12 minutes
Temperature recovery time: 8 minutes
Minimum water pressure: 1bar
Maximum water pressure: 8bar
Temperature range: 65 -100°C
Product weight: 2.8kg (empty) - 4.7kg (full)
Approvals: CE mark



Safety lock lever



Compact and simple connection

Sensaboil Beverage Boilers

Commercial Wall Mounted Water Boiling Units

A range of six wall mounted boiling units with capacities to deliver the necessary permanent beverage preparation in catering venues such as cafes, teashops, snack bars and offices.

Key features

- Automatically fills and heats, dispensing water at 98°C upon demand
- Easy to use patented chrome tap with constant flow lock or flow hold and release operation
- Initial cup draw off 20 (3L), 34 (5L) & 51 (7.5L)
- Stainless steel tank for great tasting drinks
- Touch control on/off operation with indication and 'descale now' warning



Catalogue Number	Model/Description	Ltrs:
22672801	SB3W Sensaboil 3L White	3
22673801	SB5W Sensaboil 5L White	5
22674801	SB7W Sensaboil 7.5L White	7.5
22672805	SB3S Sensaboil 3L Stainless Steel	3
22673805	SB5S Sensaboil 5L Stainless Steel	5
22674805	SB7S Sensaboil 7.5L Stainless Steel	7.5

Technical information

Heating: 3kW@240V element with boil dry thermal protection

Materials: Catering grade Stainless Steel with thermally insulated jacket

Cable connection: Internal terminal block for hardwiring

Operating pressure: 1 - 8bar maximum

Water connection: 3/4" BSP inlet connector and 2mtr hose supplied

Weight empty: 4.8kg (3L), 6.2kg (5L & 7.5L)

Weight full: 7.8kg (3L), 11.2kg (5L), 13.7kg (7.5L)

Dimensions: 3L 344mm (w) x 346mm (h) x 195mm (d)
5 & 7.5L 344mm (w) x 497mm (h) x 195mm (d)

Approvals: CE mark

Ingress Protection: IPX4

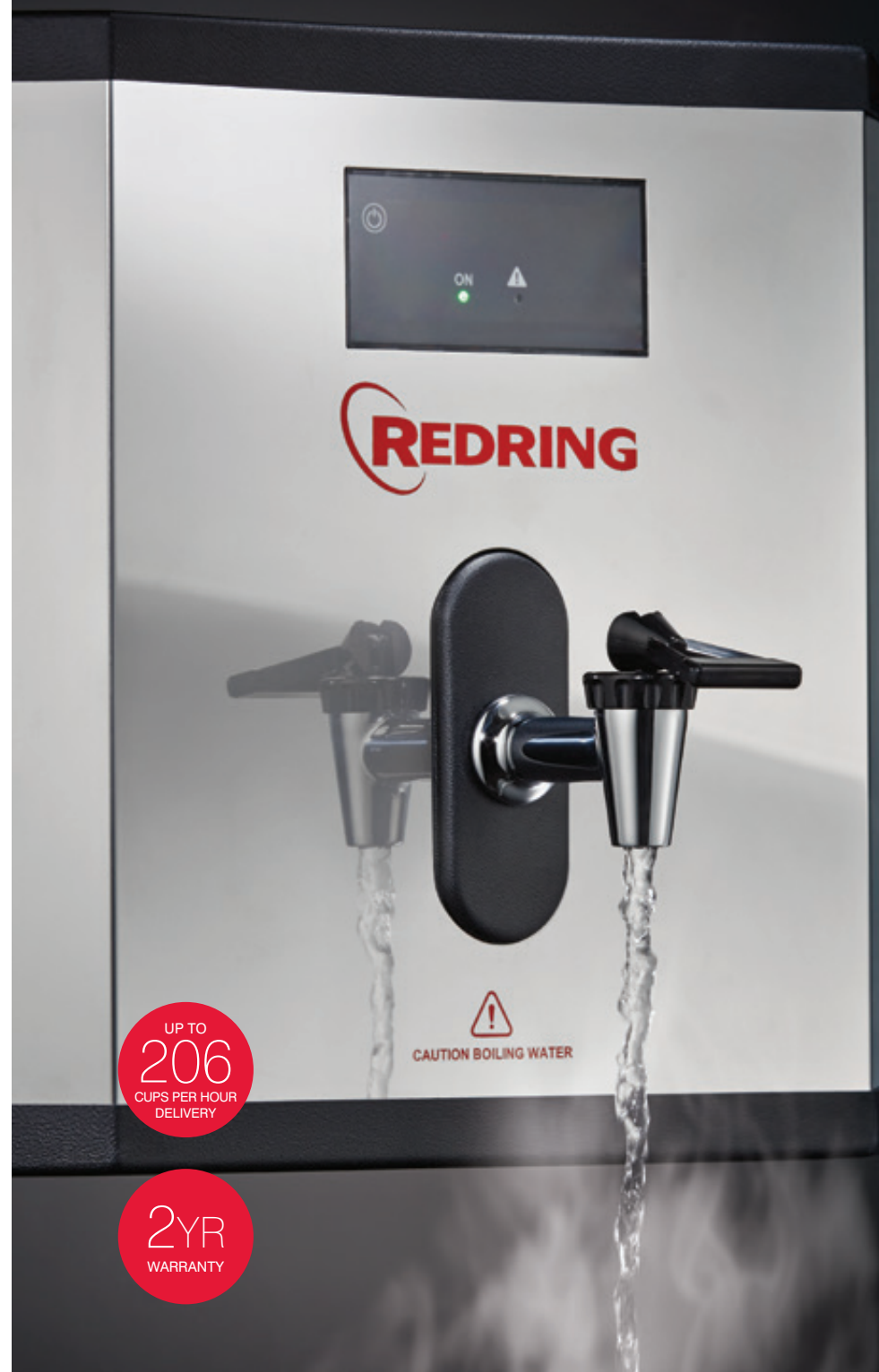

SB Counter Top & Urn Boilers

Commercial Freestanding Boiling Units

Where wall mounting is not a practical option and portability a definite advantage, these boiling units deliver the necessary flexibility for permanent and temporary beverage preparation in catering venues such as cafes, teashops, snack bars and office meetings.

Key features

SB Counter Top Unit

- Auto-fill and boil permanently plumbed unit with removable drip tray
- On/off touch control panel with descale alert
- Dual operation tap with push to lock for continuous flow or hold and release manually regulated dispense

Urn Boiling Unit

- Manual fill, and top up as required, portable catering Urn with twist-lock lid and carry handles
- Six setting thermostatic control (37°C to 97°C) with 'Heat On' neon indicator
- Dual operation tap with push to lock for continuous flow or hold and release manually regulated dispense



Boiling Urn

Catalogue Number	Model/Description	Ltrs:
22679301	SB5CL SB Counter Top Boiler Stainless Steel	5
22715101	URN1 Boiling Urn Stainless Steel	10

Technical information

Heating: 3kW@240V element with boil dry protection

Cable connection: Fitted cable and 13amp UK plug

Materials: Catering grade Stainless Steel

Operating pressure: 1 - 8bar max. (counter top unit only)

Water connection: 3/4" BSP inlet connector and 2mtr hose supplied with counter top. Urn is manually filled by removing the lid

Dimensions: Counter Top 358mm (w) x 457mm (h) x 464mm (d)
Urn 335mm (w) x 380mm (h) x 305mm (d)

Approvals: CE mark

Ingress Protection: IPX4



Counter Top



1 YR
WARRANTY

£
AFFORDABLE
PRICE



www.redring.co.uk

Sales

0844 372 7750*

The team can be contacted from 8:30 until 17:00 Monday to Friday.

rxsalesoffice@redringxpelair.com

Technical

0844 372 7766*

Our UK based call centre is open Monday to Friday from 8:30 until 17:00.

technical.services@redringxpelair.com

*Calls cost 7p per minute plus your telephone company's network access charge.

R088 (July 2017)